

## TO-92 Plastic-Encapsulate Transistors

### FEATURES

- Switching and amplification in high voltage
- Applications such as telephony
- Low current
- High voltage
- NPN Transistors

### MECHANICAL DATA

- Case style: TO-92 molded plastic
- Mounting position: any

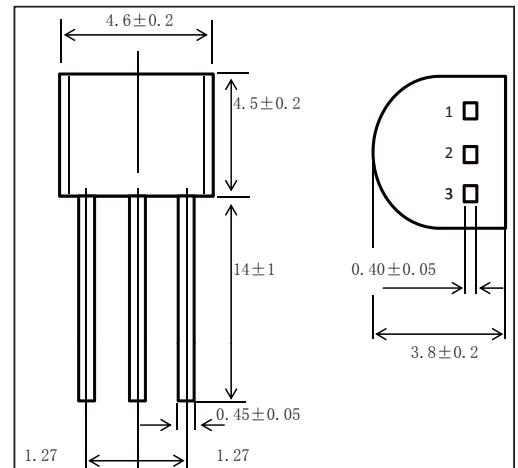

### MAXIMUM RATINGS AND CHARACTERISTICS

@ 25°C Ambient Temperature (unless otherwise noted)

Parameter	Symbol	Value	Units
Collector-Base Voltage	$V_{CBO}$	-60	V
Collector-Emitter Voltage	$V_{CEO}$	-50	V
Emitter-Base Voltage	$V_{EBO}$	-5	V
Collector Current -Continuous	$I_C$	-100	mA
Total Device Dissipation	$P_D$	250	mW
Junction Temperature	$T_J$	150	°C
Junction and Storage Temperature	$T_{stg}$	-55-150	°C

\* These ratings are limiting values above which the serviceability of any semiconductor device may be impaired

Parameter	Symbol	Test Conditions	Min	Typ	Max	Unit
Collector-base breakdown voltage	$V(BR)_{CBO}$	$I_C = -50\mu A, I_E = 0$	-60			V
Collector-emitter breakdown voltage	$V(BR)_{CEO}$	$I_C = -1mA, I_B = 0$	-50			V
Emitter-base breakdown voltage	$V(BR)_{EBO}$	$I_C = -50\mu A, I_C = 0$	-5			V
Collector cut-off current	$I_{CBO}$	$V_{CB} = -60V, I_E = 0$			-0.1	$\mu A$
Emitter cut-off current	$I_{EBO}$	$V_{EB} = -5V, I_C = 0$			-0.1	$\mu A$
DC current gain	$h_{FE}$	$V_{CE} = -6V, I_C = -1mA$	90	200	600	
Collector-emitter saturation voltage	$V_{CE(sat)}$	$I_C = -100mA, I_B = -10mA$		-0.18	-0.3	V
Base-emitter voltage	$V_{BE}$	$V_{CE} = -6V, I_C = -1.0mA$	-0.58	-0.62	-0.68	V
Transition frequency	$f_T$	$V_{CE} = -6V, I_C = -10mA$	100	180		MHz
Collector output capacitance	$C_{ob}$	$V_{CB} = -10V, I_E = 0, f = 1MHz$		4.5	6	pF
Noise figure	NF	$V_{CE} = -6V, I_C = -0.3mA, R_g = 10k\Omega, f = 100Hz$		6	20	dB

RATINGS AND CHARACTERISTIC CURVES

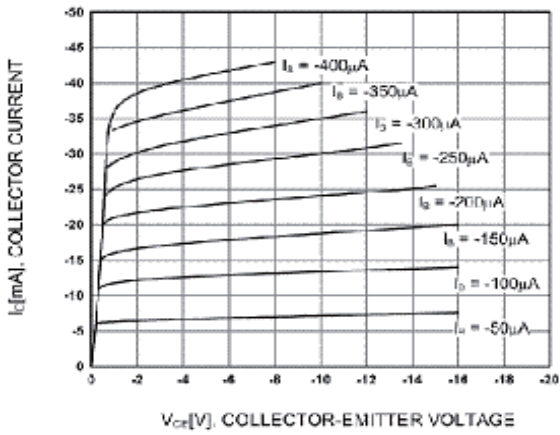

Static Characteristic

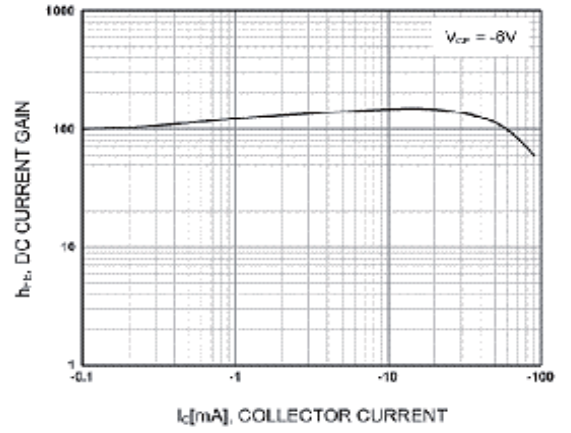

DC current Gain

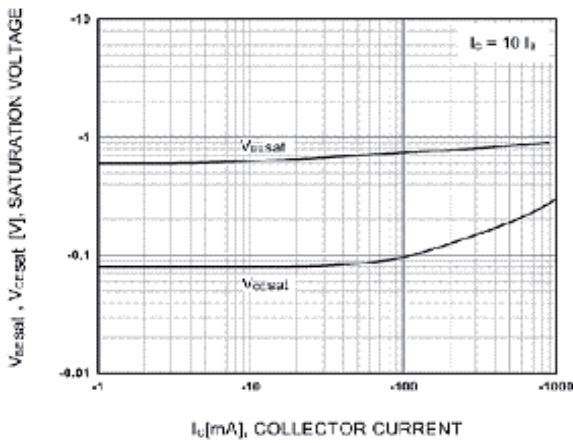

Base-Emitter Saturation Voltage  
Collector-Emitter Saturation Voltage

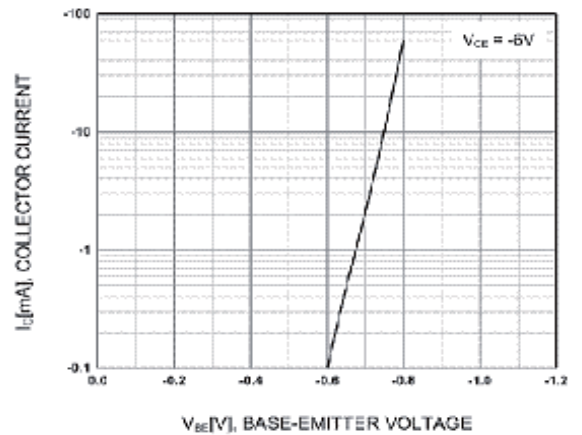

Base-Emitter On Voltage

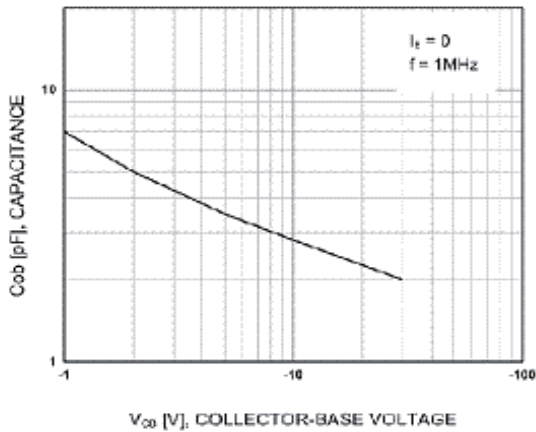

Collector Output Capacitance

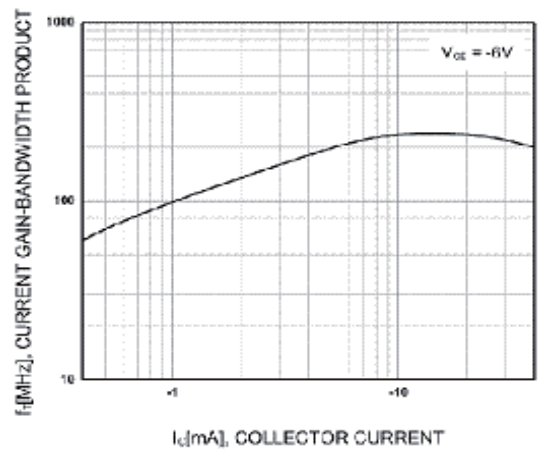

Current Gain Bandwidth Product